

TREASURE CHEST

Finishing Instructions

Supplies:

Large Flying Geese Ruler
 InvisiGRIP™

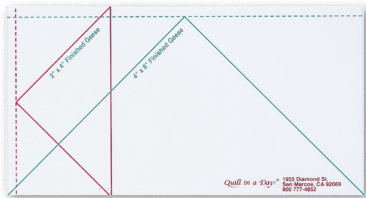

	Background	2 1/8 yds
	Geese Border	(5) 11" strips cut into (14) 11" squares
	Geese Border	(2) 8 1/2" strips cut into (2) 8 1/2" x 20 1/2" (2) 8 1/2" x 16 1/2"
	Dark Blue	1 3/4 yds
	Geese Border	(4) 9 1/2" strips cut into (14) 9 1/2" squares
	Binding	(10) 3" squares
	Outside Border	(10) 1 1/2" strips
	Light Blue	2 1/8 yds
	Lattice/Cornerstones	(16) 4 1/2" strips
	Dark Green	1/3 yd
	Border Corners	(1) 8 1/2" strip cut into (4) 8 1/2" squares

Sewing Blocks to Lattice

Measure three of your Blocks to get an average size.

Record measurement: _____

Approximately 16 1/2"

1. Cut your Light Blue Lattice strips into (31) 4 1/2" x size of Block and (20) 4 1/2" Cornerstone squares.
2. Layout Blocks with Lattice and Cornerstones.



3. Sew to complete the Rows. Press seams towards Lattice.

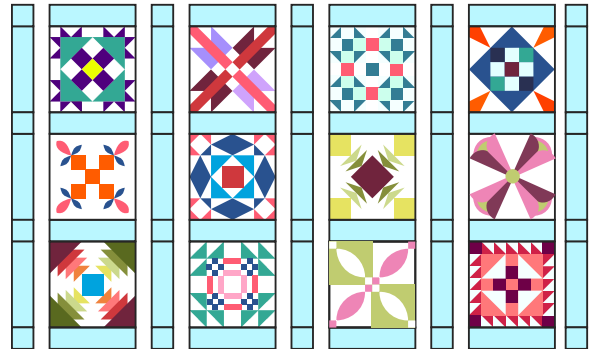

4. Sew Rows Together. Press seams towards Lattice.

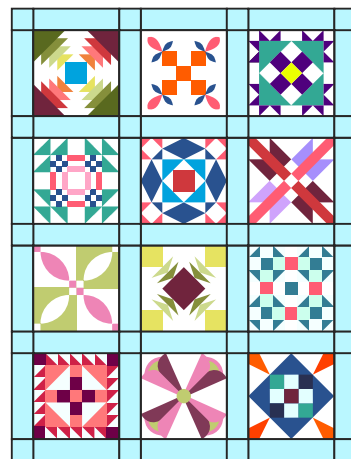



Making Flying Geese

1. Place large 11" Background square right side up.

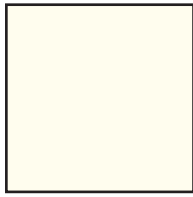

2. Place 9½" Dark Blue square right sides together and centered on 11" Background square.

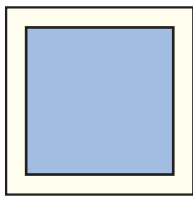

3. Place 6" x 24" ruler on squares so ruler touches through four corners. Draw diagonal line across squares. Pin.

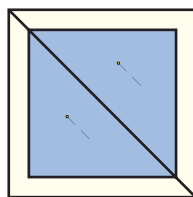

4. Sew ¼" from left side of drawn line. Use 15 stitches per inch or 2.0 on computerized machine.

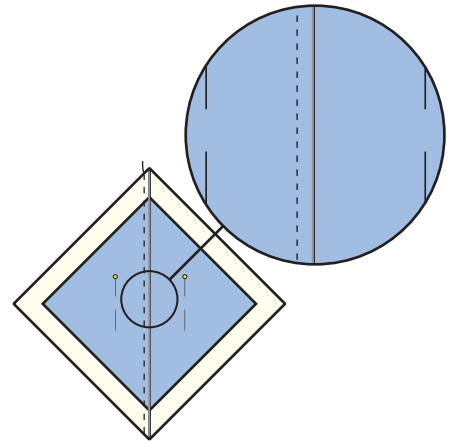

5. Turn. Sew ¼" from line on second side. Distance between two stitching lines is ½".

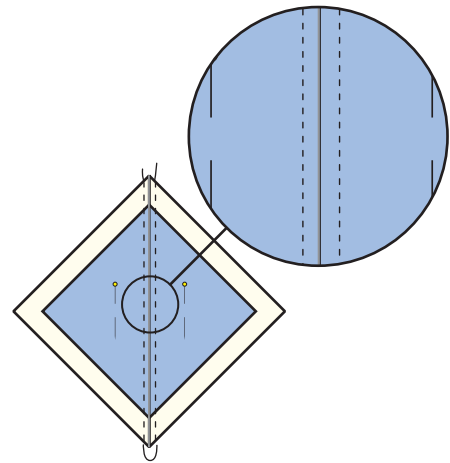

6. Cut on drawn line.

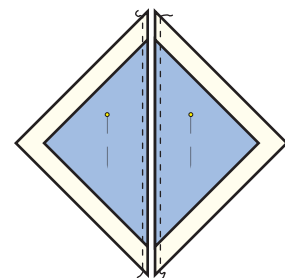

7. Place on pressing mat with large Background triangle on top. Press to set seam.

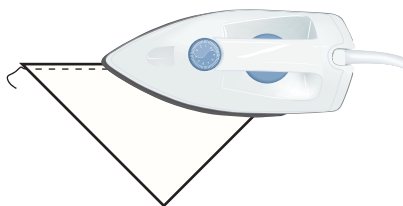

8. Open and press toward Background triangle, the largest triangle. Check that there are no tucks in seam.

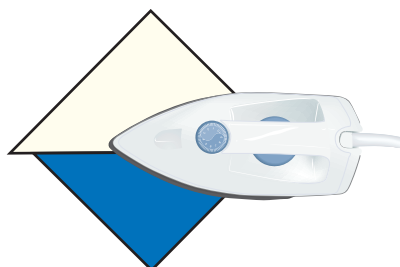

Press seam toward large triangle.

9. Place pieces right sides together so that opposite fabrics touch with Background to Geese. **Seams are parallel with each other.**

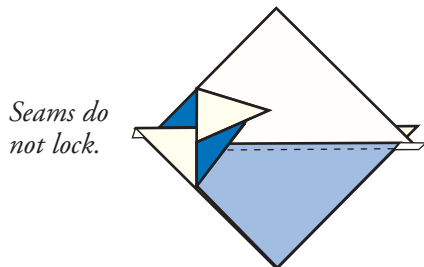

10. Match up outside edges. Notice that there is a gap between seams. The seams do not lock.

11. Draw a vertical line across seams. Pin.

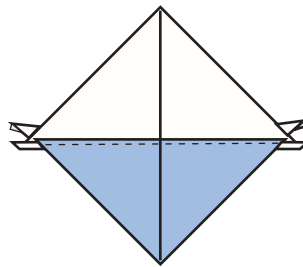

12. Sew $\frac{1}{4}$ " from both sides of drawn line. Hold seams flat with stiletto so seams do not flip. Remove pins. Press to set seam.

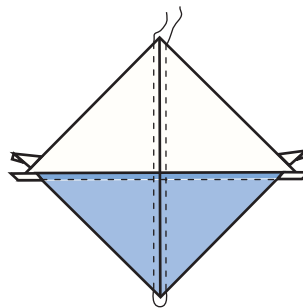

13. Cut on drawn line.

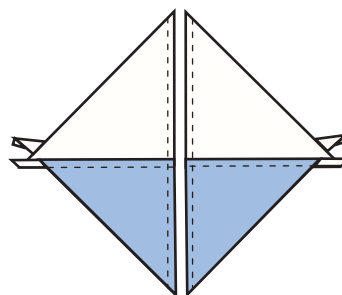

14. Fold in half and clip to stitching. This allows both seam allowances to be pressed away from Geese triangle.

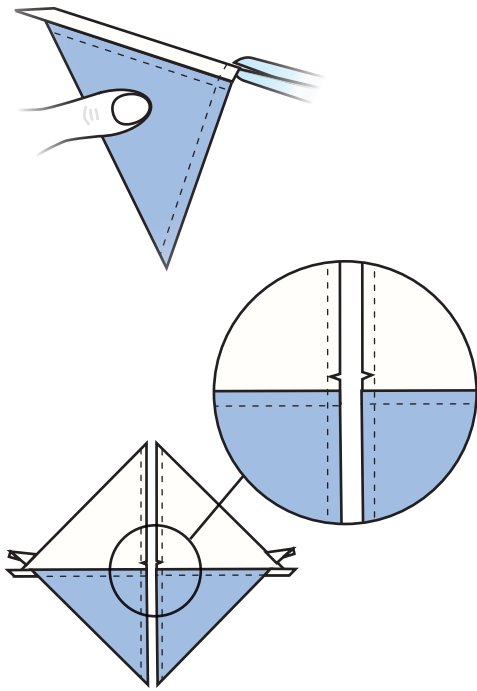

15. **From right side**, press into one Geese triangle. Turn and press into second Geese triangle.

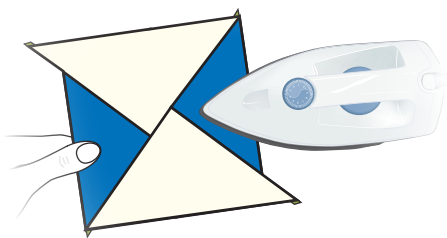

16. Turn over, and press on wrong side. At clipped seam, fabric is pressed in opposite directions toward Geese.

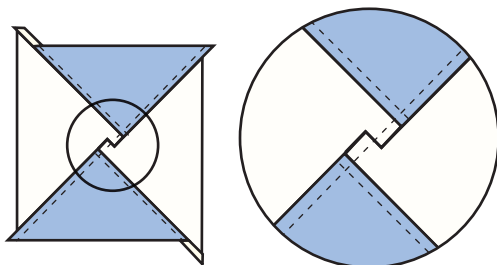

Squaring Up Geese Using Green Lines

1. Use the Large Flying Geese Ruler from Quilt in a Day. These directions are for trimming Geese using **green lines on ruler**.
2. Cut InvisiGRIP™ 1/2" smaller than Geese ruler and place on underside of ruler.
3. Place Geese patch on small cutting mat.
4. Line up ruler's **green lines** on 45° sewn lines. Line up dotted line with peak of triangle for 1/4" seam allowance.
5. Cut block in half to separate into two patches.

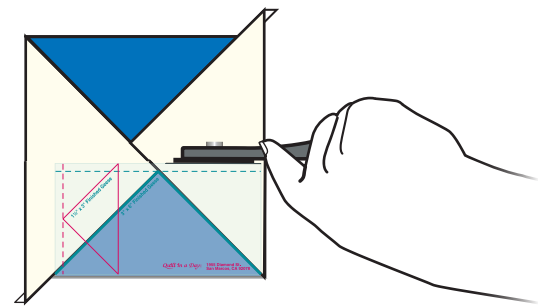

6. While turning mat, trim off excess fabric. Hold ruler securely on fabric so it does not shift while cutting.

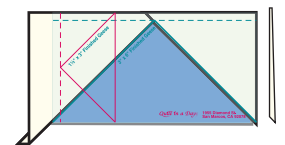

7. Check for 1/4" seam allowance on top edge. Seams go into corners on bottom edge.

Patches include seam allowance. This measurement is always 1/2" larger than finished measurement.

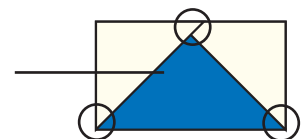

Completing the Borders

1. Sew four Rows of 6 Geese and four Rows of 8 Geese. Press Seams away from the points.

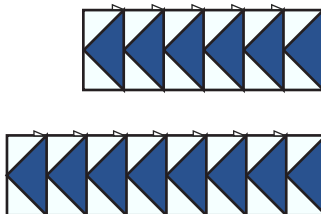

2. Sew (1) 8½" x 16½" Background piece between each set of six Geese.



3. Sew unit to the top and bottom of your quilt top. Press seams away from Geese.



4. Sew (1) $8\frac{1}{2}$ " x $20\frac{1}{2}$ " Background piece between each set of eight Geese.



5. Sew (1) $8\frac{1}{2}$ " Dark Green Square to each end. Press seam towards square.



6. Sew to each side of the Quilt top.

7. Add Dark Blue $1\frac{1}{2}$ " Border.

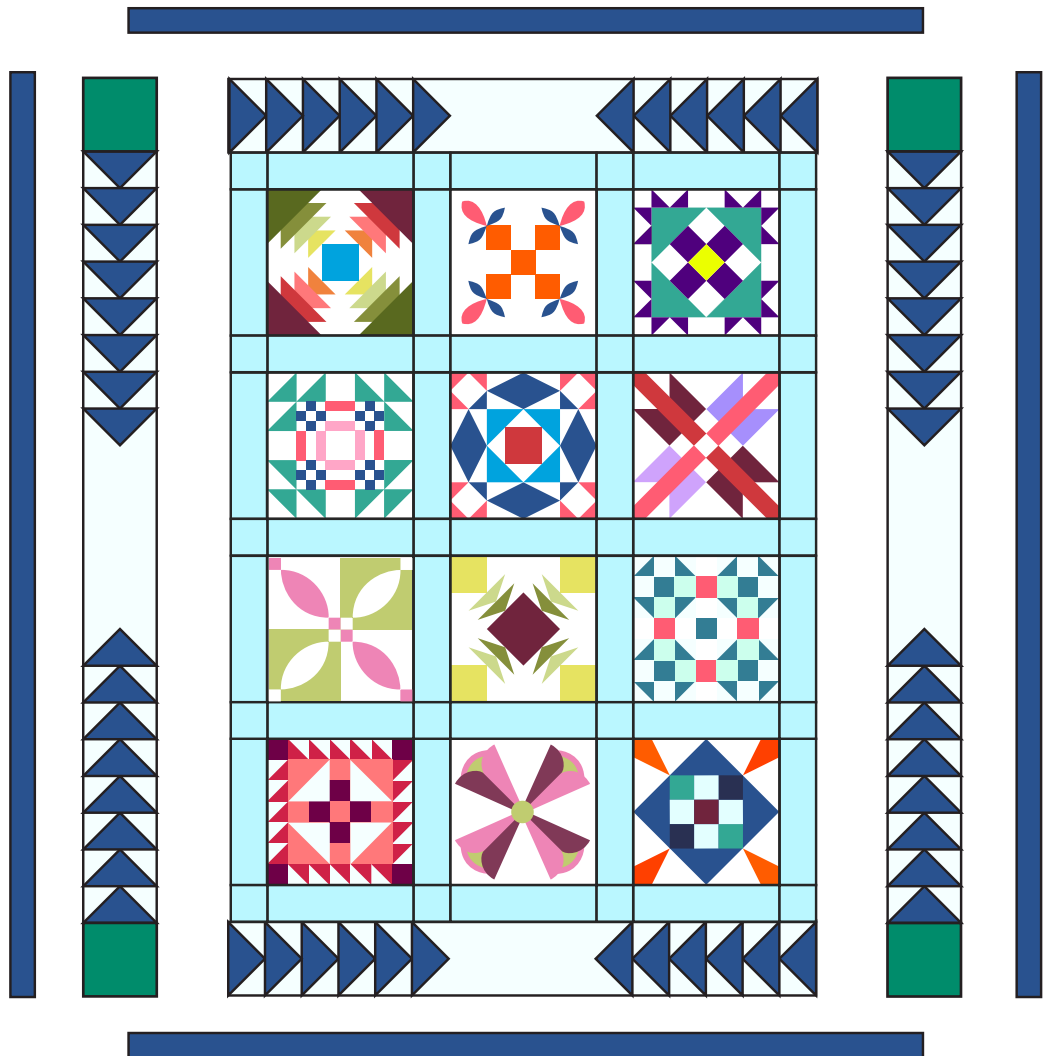

8. Quilt and Bind.